

GroSens 2.2: Core Installation Guide



GroSens 2.2: Core Installation Guide

3		Physical installation
5		Step 1: Number of Gateways & placement
7		Step 2 & 3: Placement of Bridge, connection to Gateway
8		Step 4 & 5 Placement of GroSens sensors
9		Optional: Converter to climate computer
10		Firewall
11		Detailed Installation
12		Let's Start
14		Step 1: Gateway installation
17		Step 2: Bridge installation
21		Step 3: Add GroSens Root Zone sensors
23		Step 4: Add GroSens Climate sensor
25		Step 5: Create a room/section
26		Step 6: View data on Desktop Viewer

Physical installation: Placement & mounting

Placement of gateway: important for optimal coverage

- Typical range is 150 meters (verified in greenhouse with crop)

NOTE: In indoor facilities, the range maybe less if walls/doors are between the sensor and the gateway

Placement of bridge:

- Typically placed in the office, close to server/switches/climate computer/desktop
- Infrastructure requirement: DHCP server required to give bridge IP address

Bridge and gateway connection:

- Use a good quality CAT5 full copper ethernet cable or better for connections over 10 meter.
- For long connections (>100 meter) ensure you:
 - Add PoE amplifiers (for PoE connections)
 - Add switches, long-range router or fiber (for data connections)
- Gateway requires PoE (power over Ethernet).
- Network should support DHCP

Root zone sensor: mounting and placement

- Height indicator should be tight to slab (slight resistance should be felt when inserting the root zone sensor)

Climate sensor:

- Avoid direct sunlight (will influence temperature measurement)
- Advice to place at similar position as climate computer measurement boxes

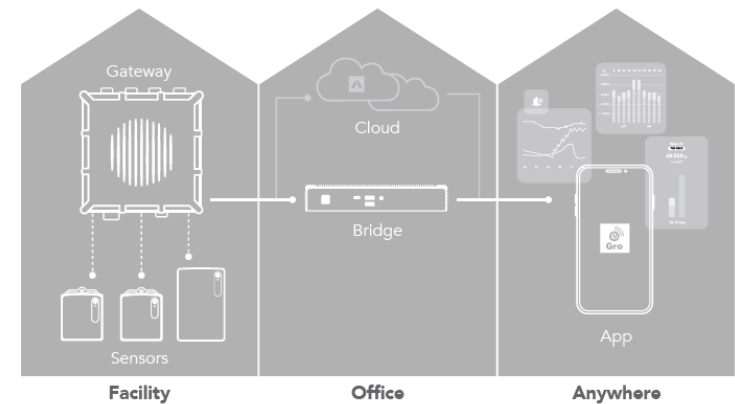

Physical installation: Ethernet and power connections

Overview of a basic 'desk' setup

- Bridge
- Power supply of the bridge
- Ethernet connection to the bridge
- PoE (power supply for the gateway → adds power to the blue ethernet cable)
- Ethernet connection to the PoE
- Ethernet + Power for the gateway
- Gateway
- Switch (not delivered by Grodan, e.g. Netgear GS105) to connect bridge/gateway/customer network. Instead of a switch cables 3 and 5 can also be plugged in directly on the customer network (cable 10 is not needed then).
- Power supply of the switch
- Ethernet connection to the customer network router with internet.
- Converter (needs 12 v power, included)
- Ethernet connection to converter

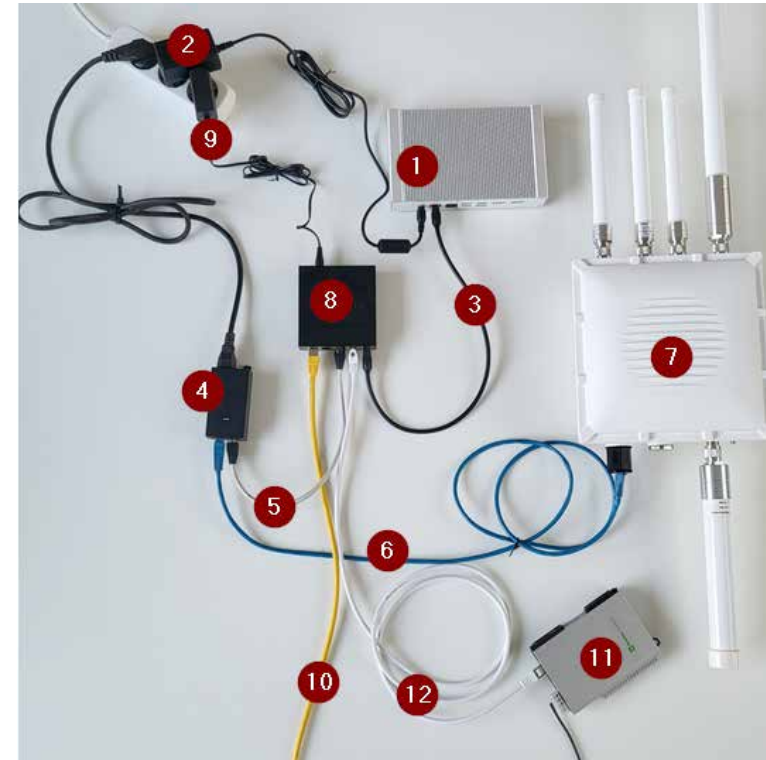

NOTE: Before installing in the greenhouse/server room it is recommended to connect the devices in an office and see if all devices can be installed via the app. Next move bridge and gateway to the actual location.

Step 1A: Number of gateways & placement

Placement of gateway is crucial for optimal coverage

Divide greenhouse into squares of 200x200 meters and put gateway in the middle of each square

Squares larger than 200x200 meters will suffer from coverage loss in corners

Note: 150 meters range holds for placement high in the greenhouse (6 meters or higher).

Example 4 ha greenhouse

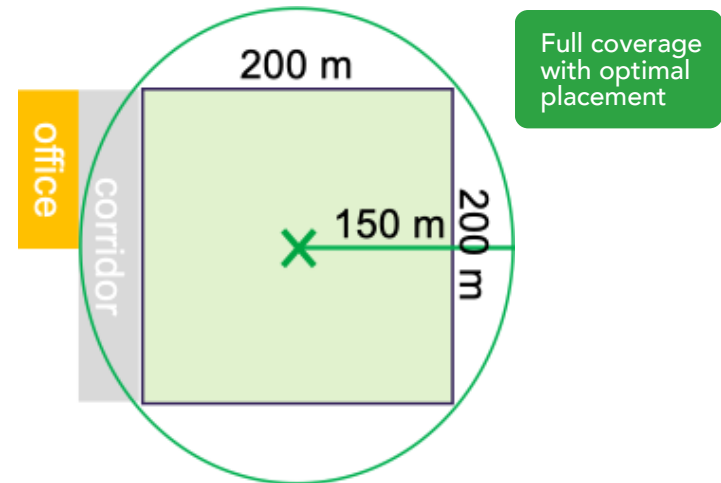

Example 6 ha greenhouse

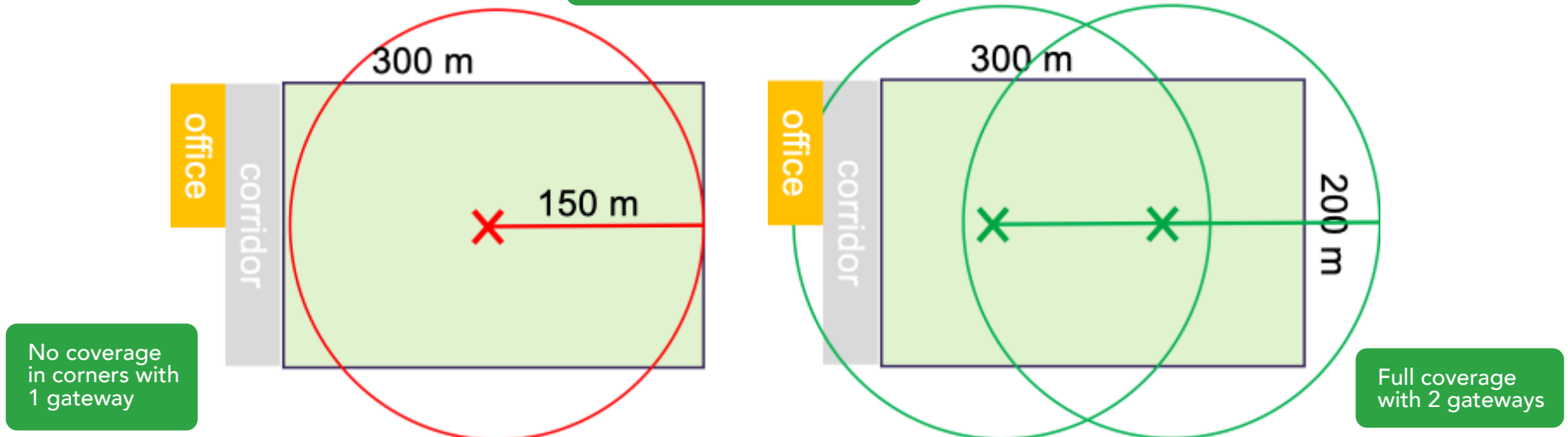

Step 1B: Gateway mounting

Gateway to be put as high as possible in greenhouse

- Crops contain water and will cause interference. High placement (> 6 meter) of gateway will result less interference of the crops.
- Indication of range:
 - placement at 6 meters height → range about 150m

Avoid interference of antennas with shields, windows or other moving elements

Antennas must be in vertical direction – LoRa antenna on top

- Horizontal antennas reduce the range
- Ethernet connection must be on bottom side to reduce risk of water leakage
 - Casing is waterproof when mounted correctly

Use custom-made bracket for rectangular poles

- Bracket has been designed for poles up to 110x110 mm as 90% of the greenhouses use this set up. In case that recommendation does not fit: hole drilling or a custom solution is necessary
- Bracket has long arm to separate antennas from metal pole to optimize the range
- Bracket has been optimized for ease of mounting

Outdoor placement

- Can increase the range significantly with more than 300 meter range possible
- Requires careful installation to take care of lightning risks

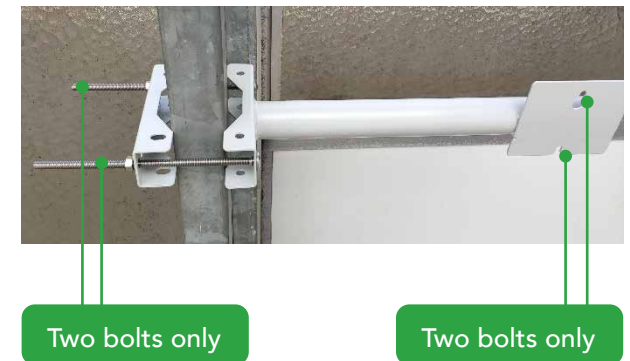
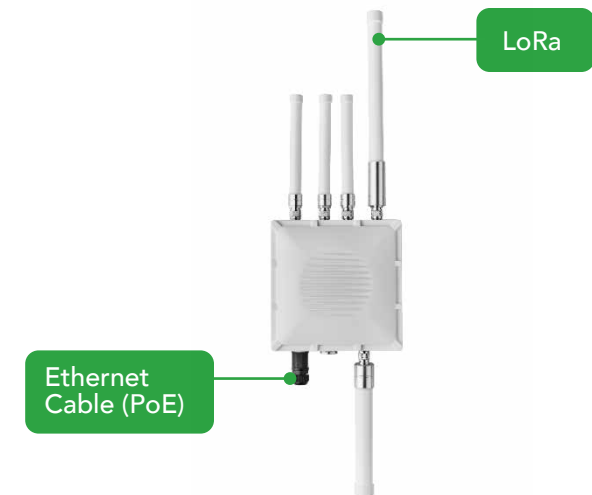

Step 2 & 3: Placement of bridge, connection to gateway

Placement of bridge is not critical. Considerations are:

- Usually placed in the office close to other IT equipment (PCs, climate computer, switches/router)
- Bridge needs to be connected to internet (advice is to have at least 20 Mb/s internet connection)
- Bridge has passive cooling (no fan)
- Avoid excessive heat (ambient temperature should stay <50 deg C)

Bridge and gateway must be connected through ethernet cable

- Bridge and gateway must be in same network (LAN) with DHCP support
- Most connections will be longer than 100 m (100 meter is maximum range for regular ethernet)
 - Use full copper cat5 or better ethernet cabling
 - Use simple router as repeater every 100 m
 - Use special long-range switches with ranges up to 200 m*
 - Use fiber connection (including fiber-ethernet converters)
 - After the PoE you have a limited range. Use full copper cat5 or better ethernet cabling to reach up to 100 meter after the PoE

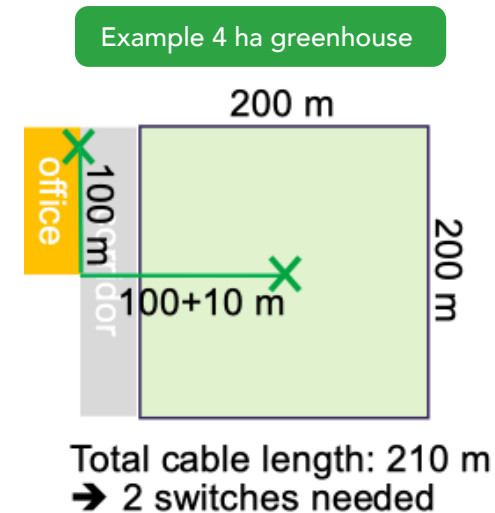

Note: Grodan is not a network installer as such please work with a reputable network provider. We can give advice but are not responsible for the proper network setup and internet connection at the grower.

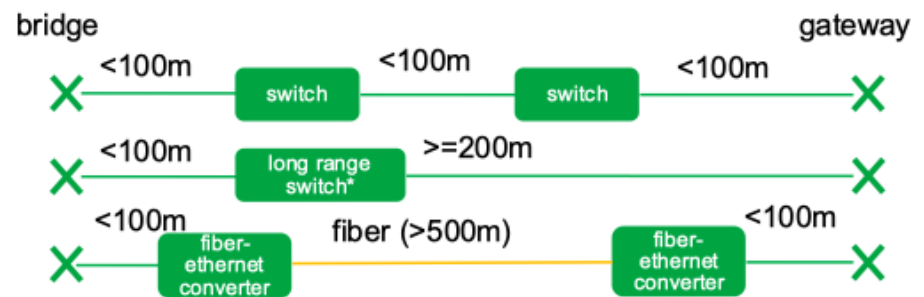

Step 4 & 5 Placement of GroSens sensors

GroSens Rootzone sensor mounting

- Alignment plate mounted with single screw which can be changed easily
- Very clear slab height indicator on back of sensor

GroSens Rootzone placement

- Use the height indicators on the sensor to position in the slab or block

GroSens Climate sensor mounting

- Hanging with wire or chain
- Pole mount using tie wrap
- Wall mount is possible but not recommended – air flow is reduced when placed against wall

GroSens Climate sensor placement considerations

- Place in similar position as the climate computer sensor is recommended
- Ensure sufficient air flow for accurate measurements
- Avoid direct sunlight to prevent impacts to temperature read-out (up to 5 deg C difference possible)

Rootzone sensor placement

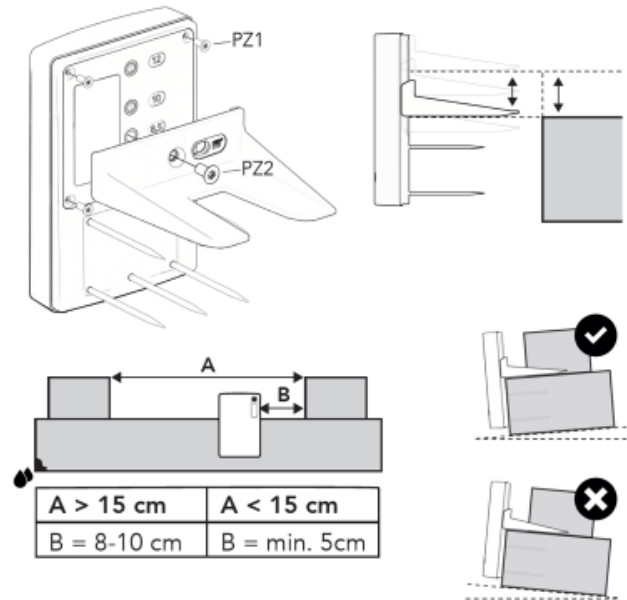

Climate sensor placement

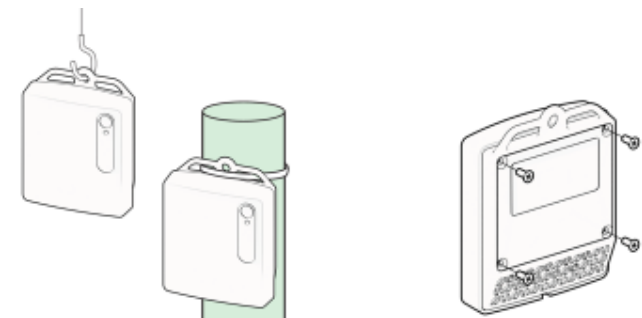

Optional: Converter to climate computer

Converter placement

- Placement between router and climate computer.

Input of the converter

- V+/V-: 5 volts
- Ethernet cable from router (bridge should be connected in same network).

Output of the converter

- VO0 (0-5 volts): WC 0-100%
- VO1 (0-5 volts): EC 0-20 mS/cm
- VO2 (0-5 volts): Temperature 0-50 degrees Celsius

Outdoor placement

- Can increase the range significantly with more than 300 meter range possible
- Requires careful installation to take care of lightning risks

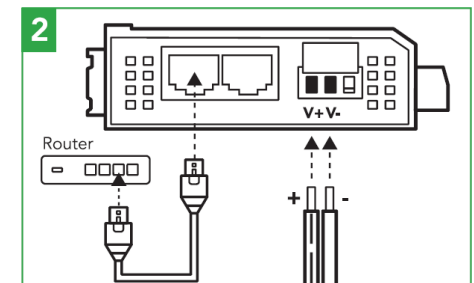
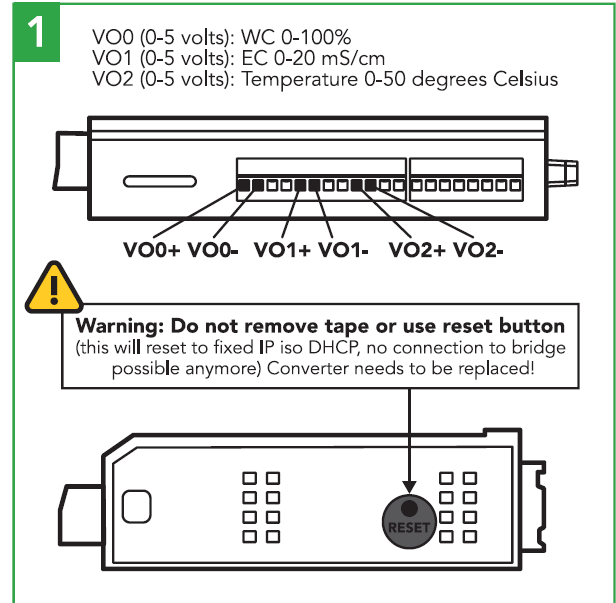

Firewall: Most facilities have firewalls installed

This could lead to problems for the GroSens bridge as it needs access to the internet domains via the following ports

The bridge makes use of the following ports:

- **443** TCP - This is the most fundamental requirement - it is used to connect to the GroSens cloud, GroSens cloud VPN and many web endpoints using TLS (https://.)
- **123** UDP - For NTP time synchronisation.
- **53** UDP - For DNS name resolution.

Additionally, you should whitelist the following domains

- **.balena-cloud.com**
updates and configuration
- **.e-gro.app**
updates and configuration
- **.grodan.com**
communication with e-Gro
- **.auth0.com**
authentication with e-Gro

Detailed Installation

(in case of issues contact egro.support@grodan.com)

Download the e-Gro Companion app to continue



Let's Start: Terms and Conditions

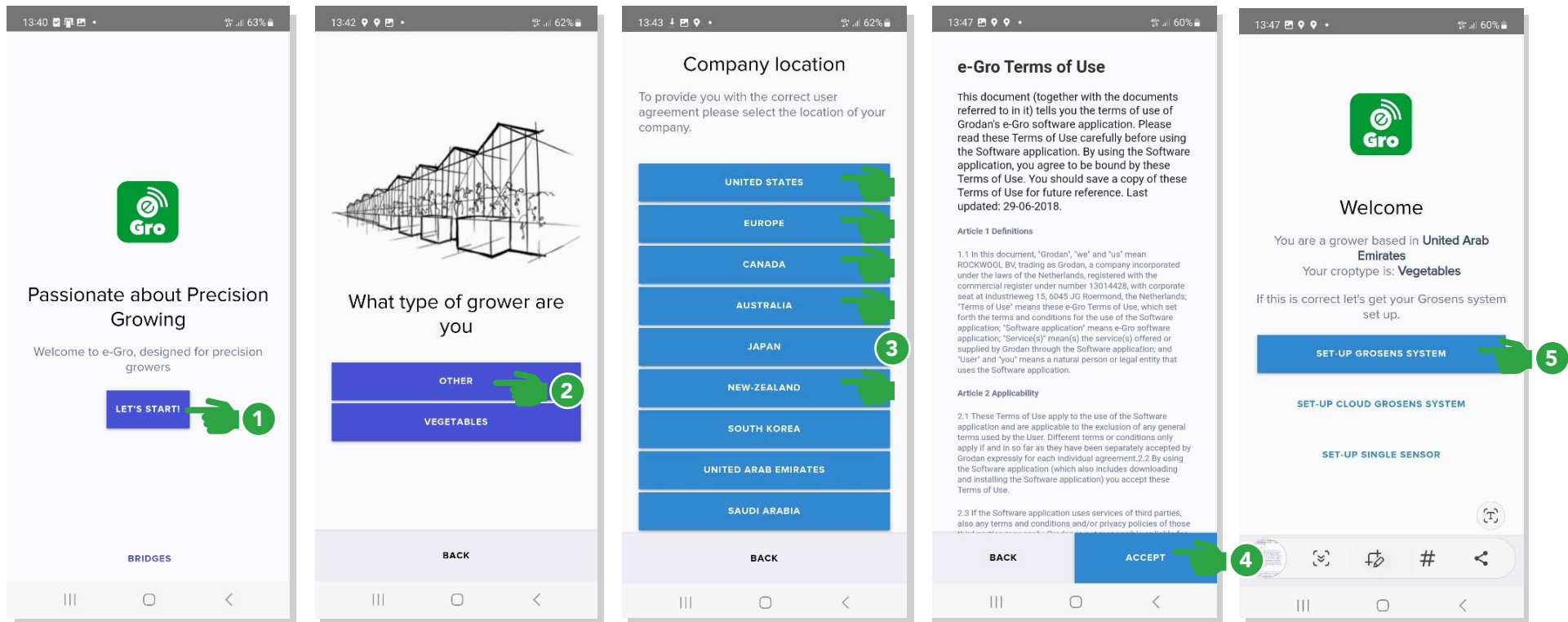

- 1 Connect phone to the LAN via WiFi for the best installation experience
- 2 Select grower type:
Vegetables: Vegetables, fruit and flower crops
Other: For medical crops
- 3 Select region the grower is located
- 4 Review and accept Terms of Use
- 5 Select set-up GroSens system

Let's Start: System explanation

e-Gro, the revolutionary software platform that allows you to collect and combine the relevant data from your greenhouse and translate it into real-time insights for data-driven Precision Growing.

Facility

With the Grosens sensors you can monitor your crops. The sensors connect to the gateway via radio signals.

Office

The gateway send the sensor data to your bridge, your office or in the cloud

Cloud

Once connected you can use the e-Gro app to get real-time insights and smart recommendations based on the root zone, climate, crop and harvest data

First the gateway need to be installed, then the bridge followed by the sensors

- ✓ Step 1: Gateway
- ✓ Step 2: Bridge
- ✓ Step 3: Sensors

BACK NEXT

BACK NEXT

BACK NEXT

BACK NEXT

BACK DONE

Step 1: Gateway installation

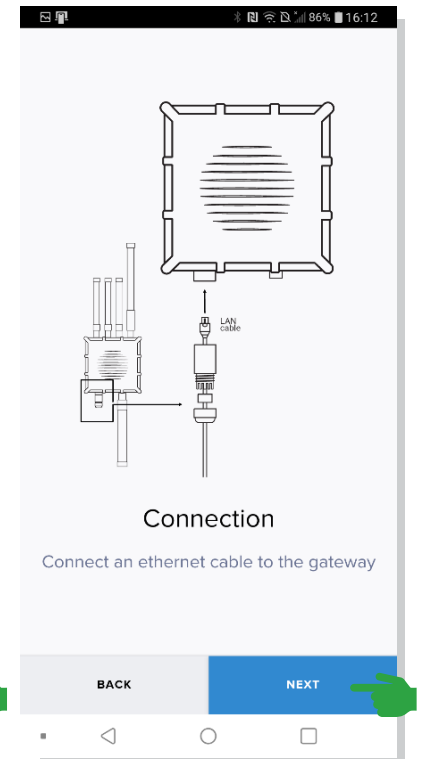
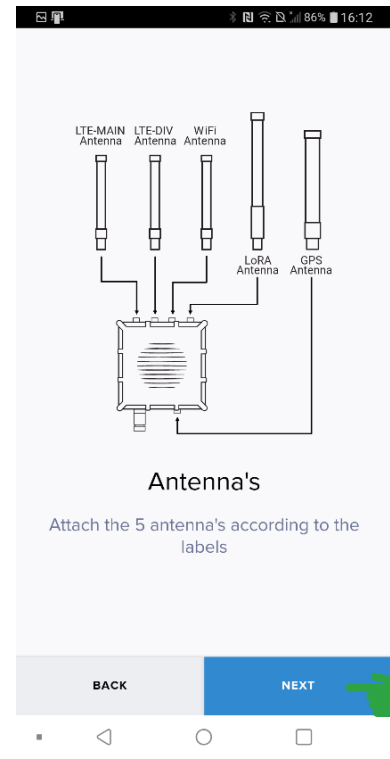
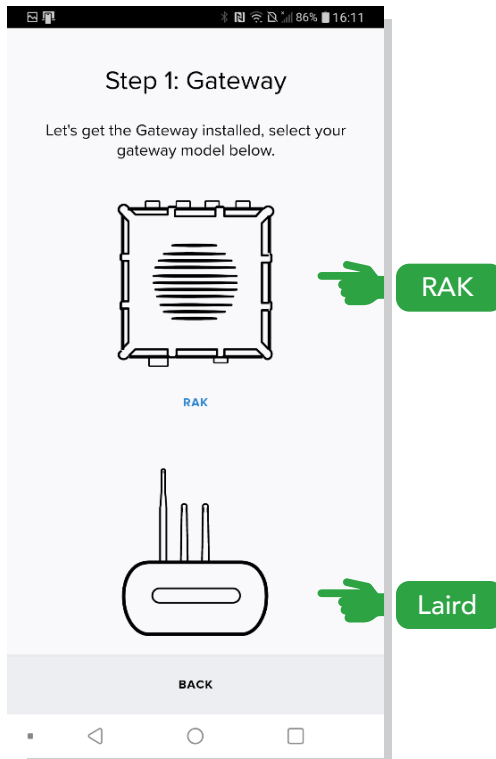
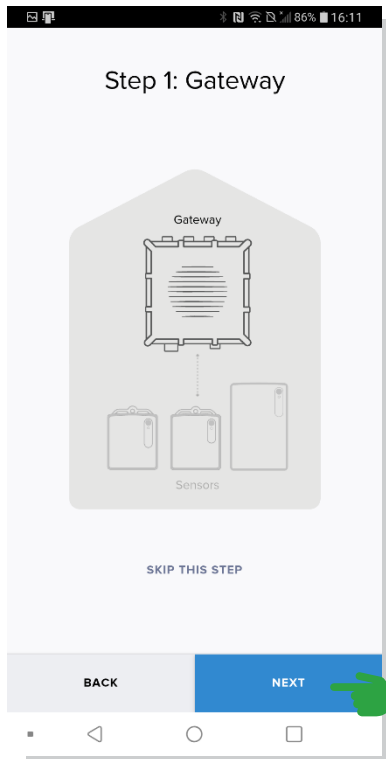

Step 1: Gateway installation

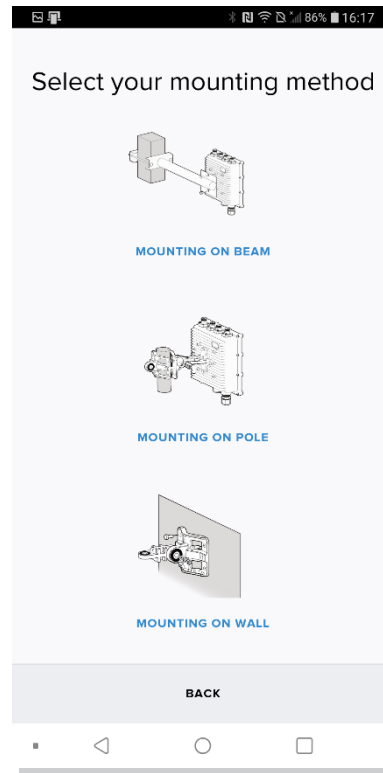
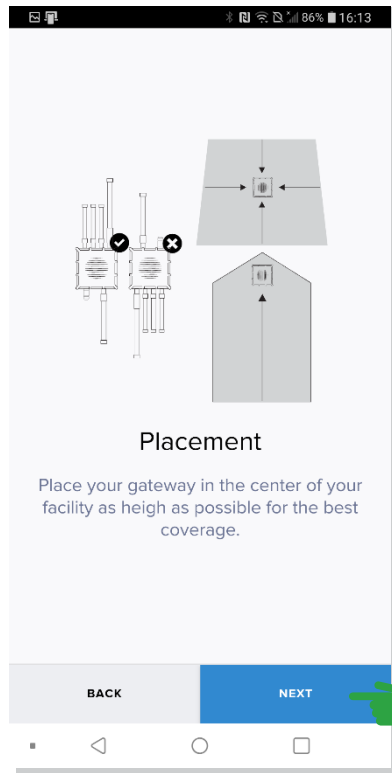
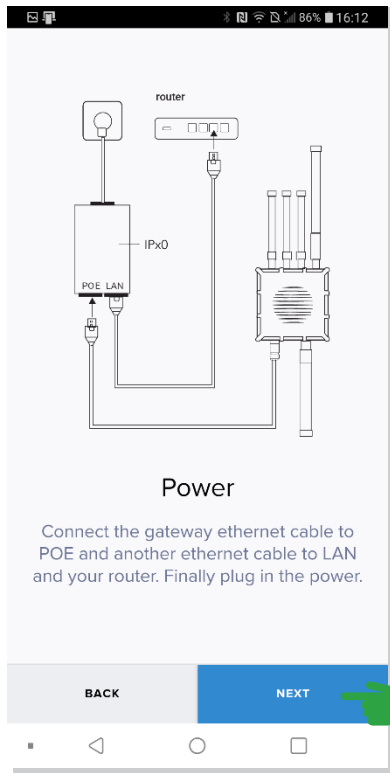

Step 1: Gateway installation

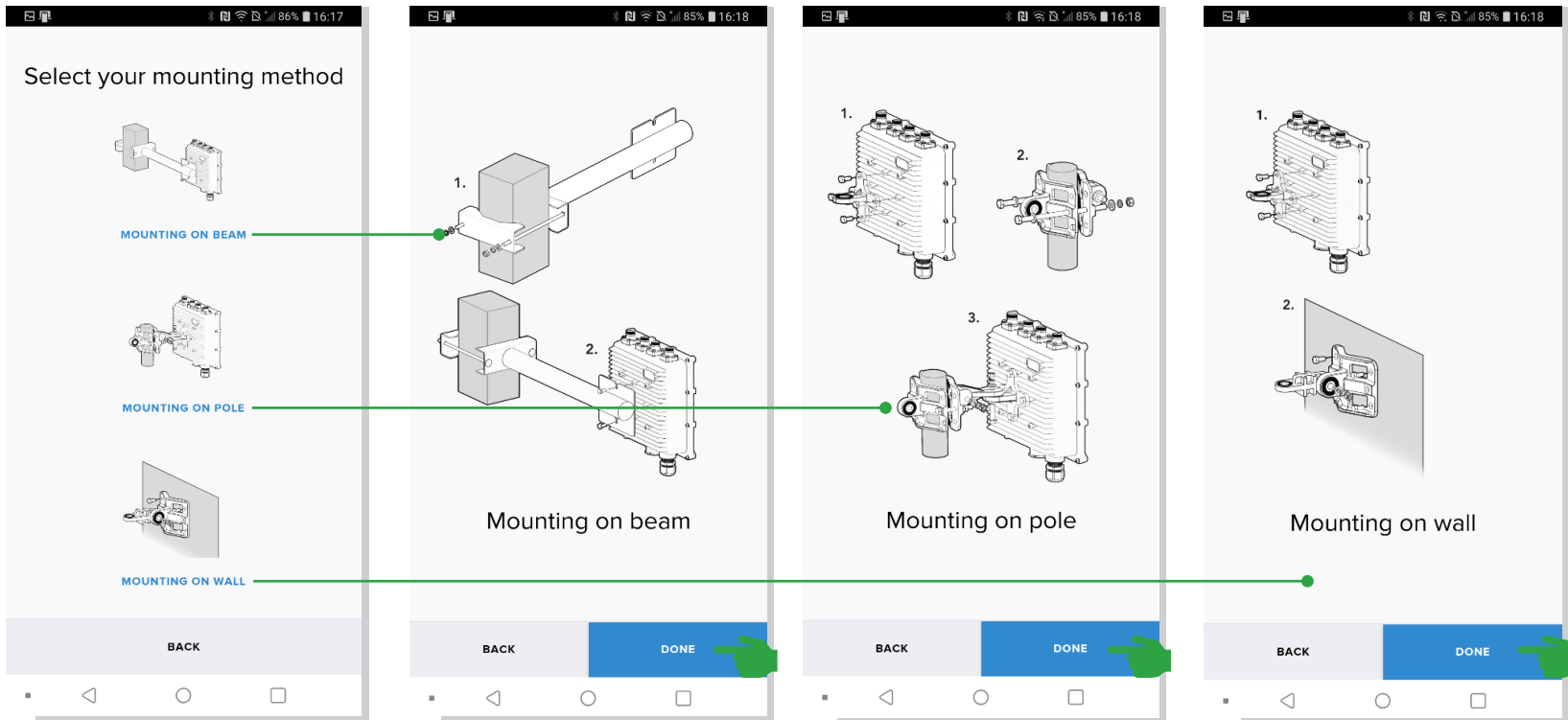

Step 2: Bridge installation

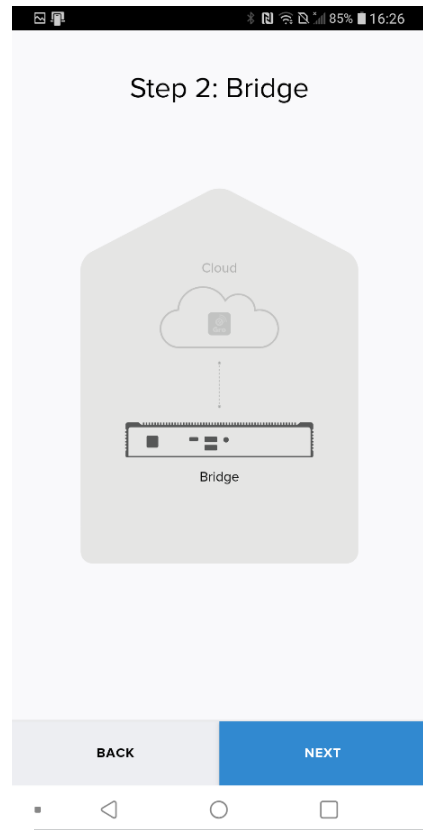
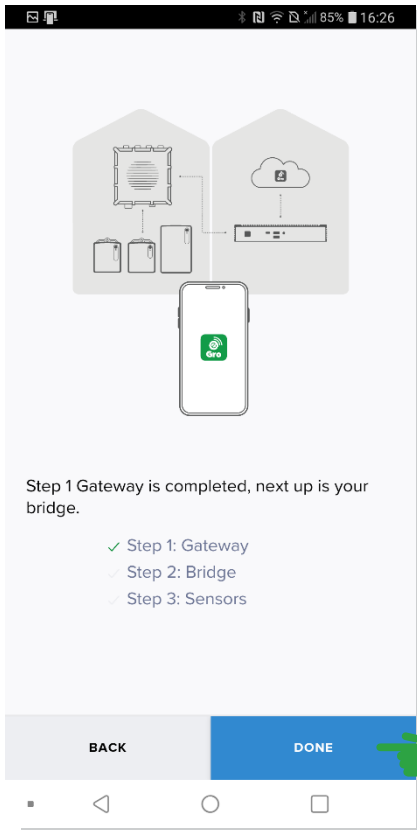

1 Scan QR code located on the bottom of your bridge

Step 2: Bridge installation

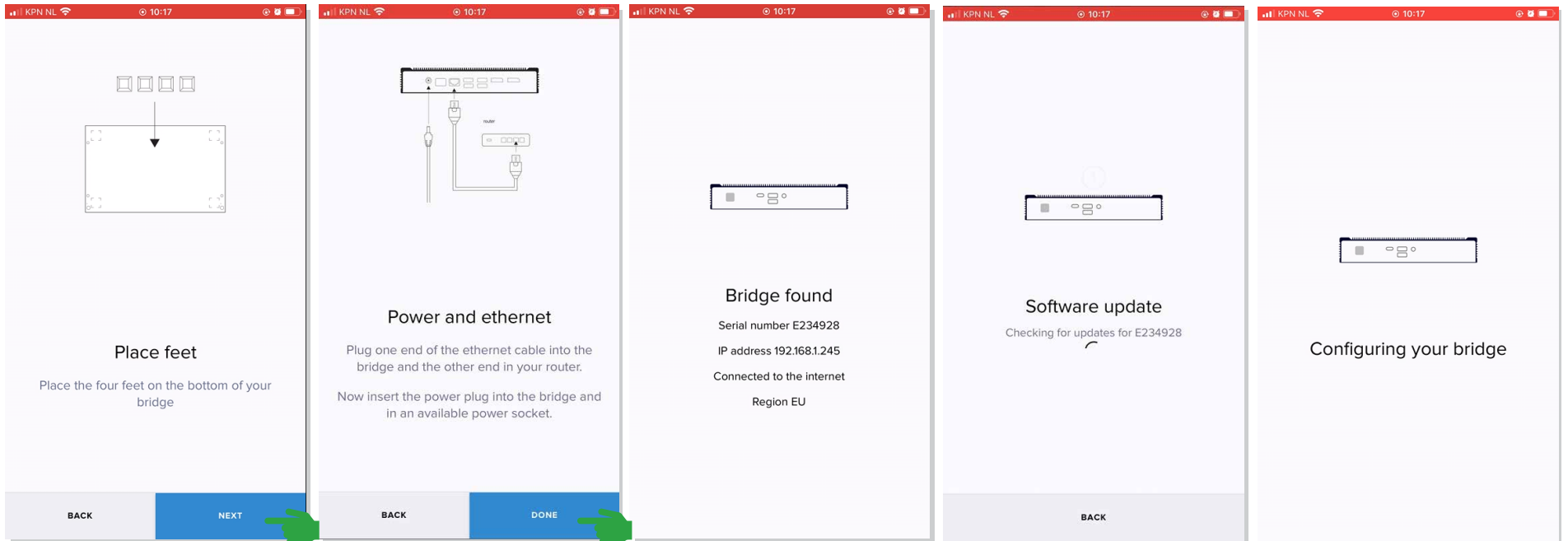

NOTE: Software update can take up to 15 minutes (based on a > 20Mb/s internet connection). Do not unplug the bridge from power during this step

Step 2: Bridge installation

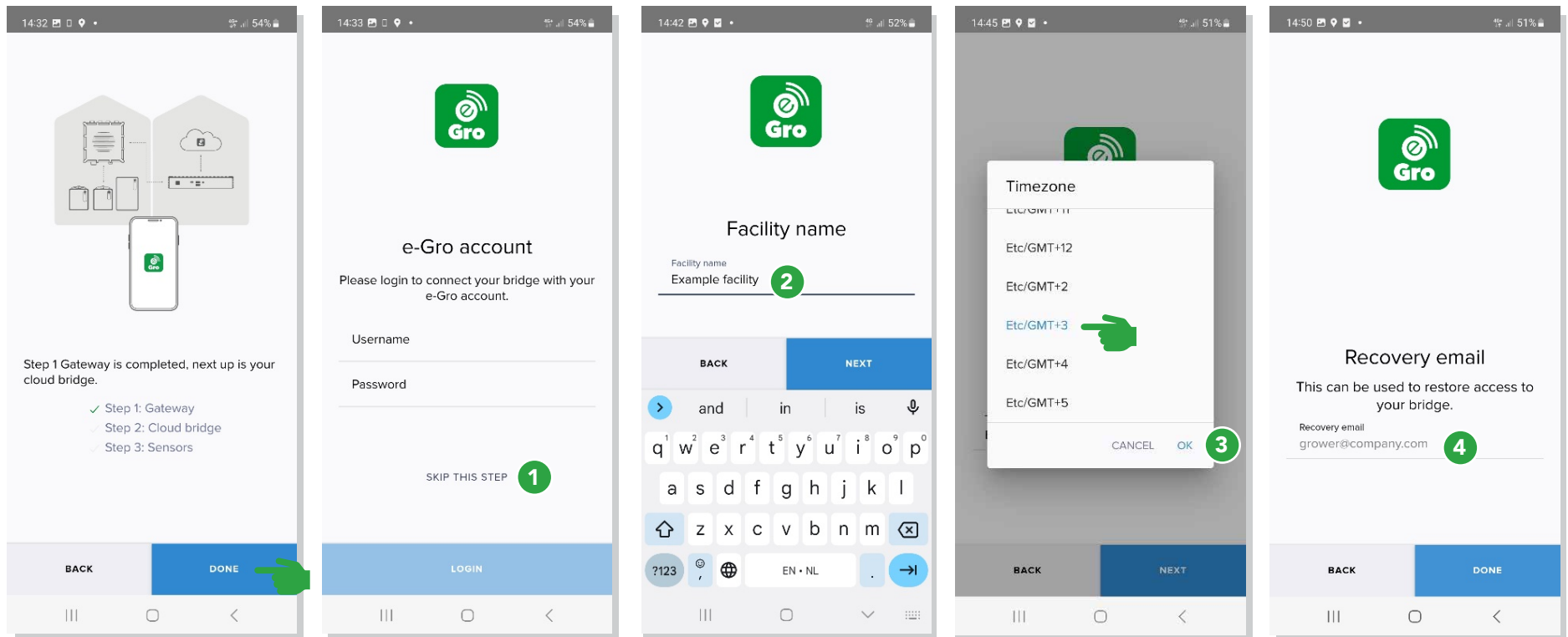

① Optional: Connection to e-Gro account.
NOTE: if you have not subscribed to e-Gro you will skip this step

② Enter facility name and press next

③ Select timezone, press OK and next

④ Enter your email address for recovery purposes. Note this is needed for events such as getting a new phone or when disconnected from the cloud bridge

Step 2: Bridge & gateway connection

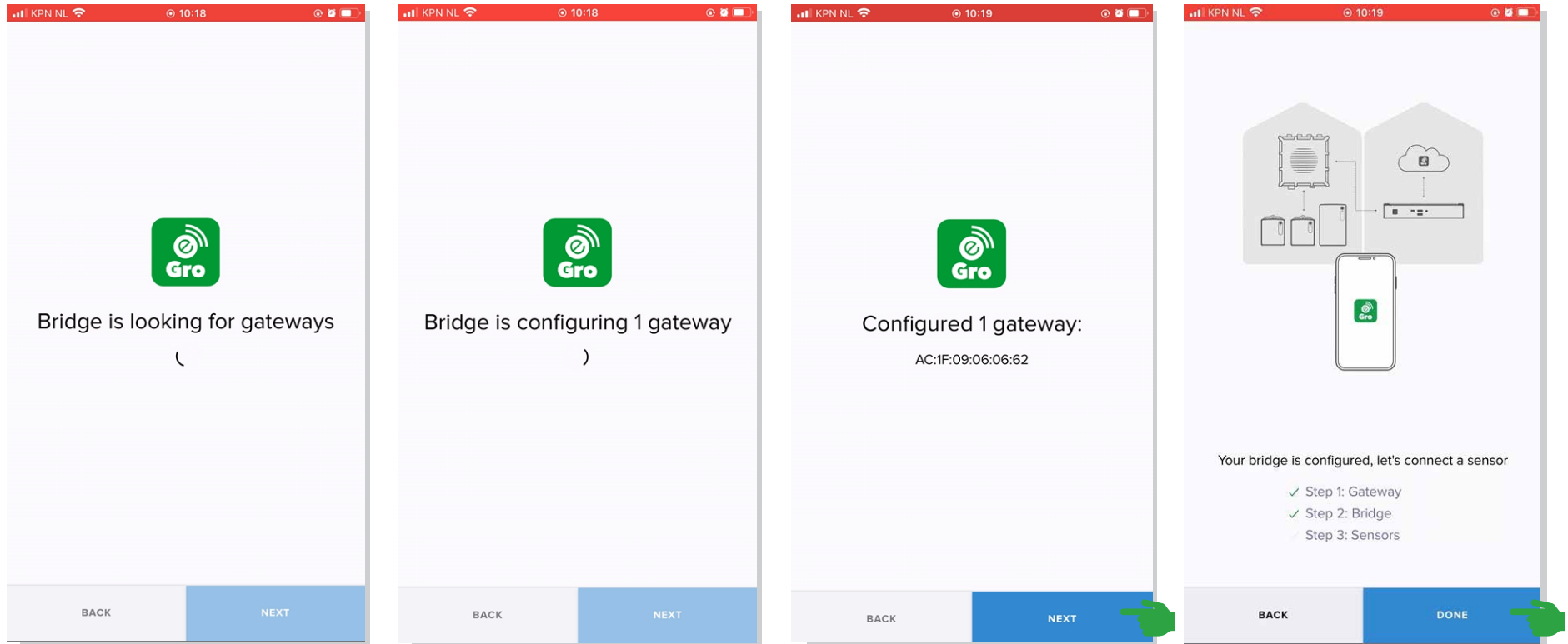

NOTE: Connection may take up to 15 minutes

Step 3: Add GroSens Root Zone sensors

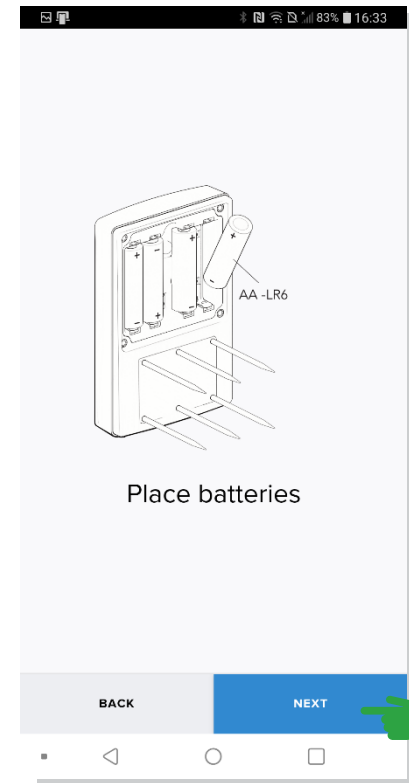
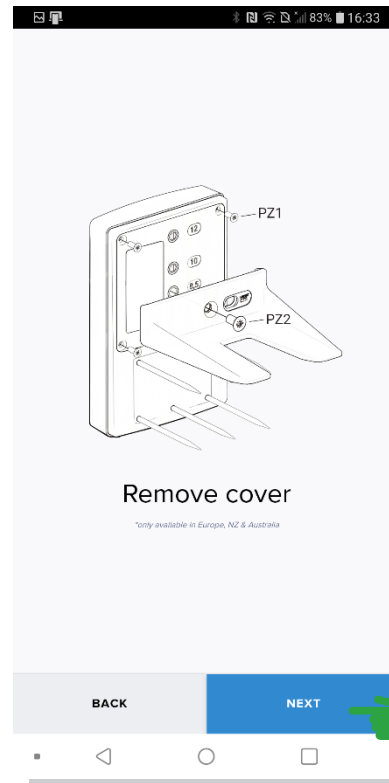
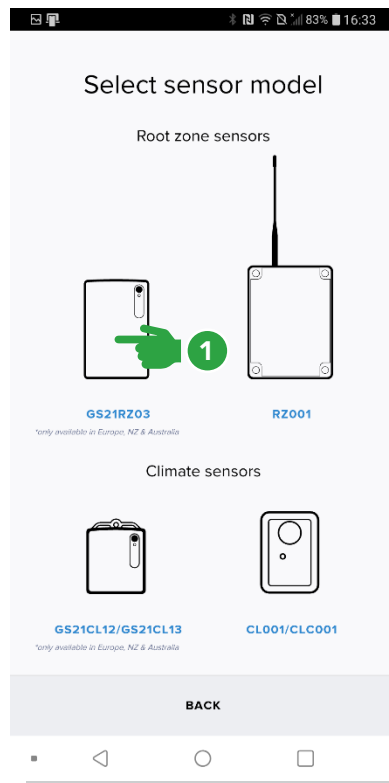
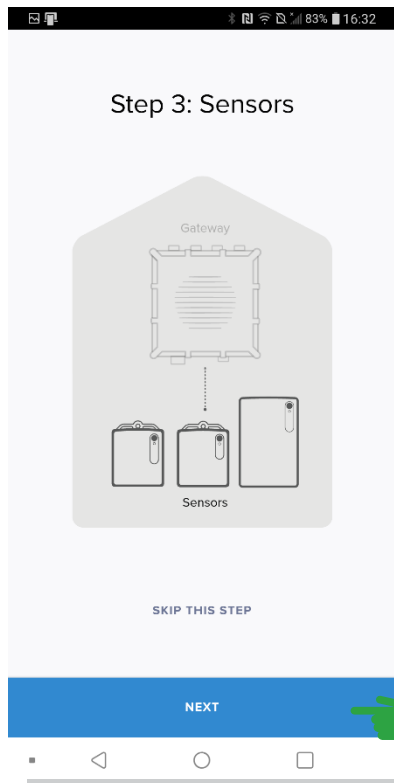

1 Select the GroSens sensor to install and follow the onscreen instructions. Additional details on the GroSens sensor installation, please refer to the GroSens installation manual

Step 3: Add GroSens Root Zone sensors

1 Press the button on the physical blue GroSens root zone sensor. The sensor number will appear in app

2 Light will start flashing

3 Press the sensor number of the sensor in the app to configure it.

Step 4: Add GroSens Climate sensor

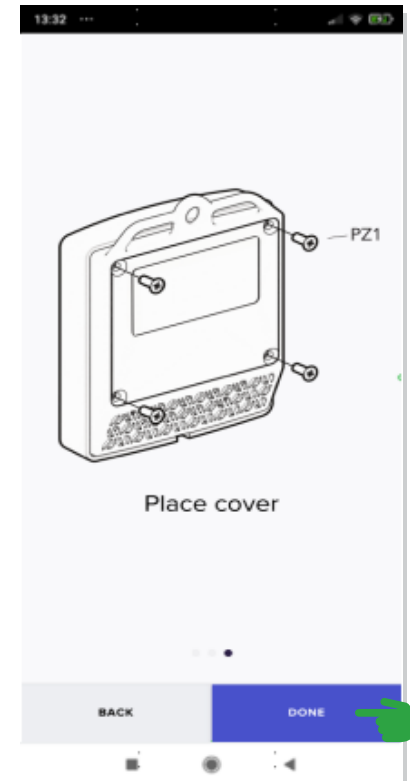
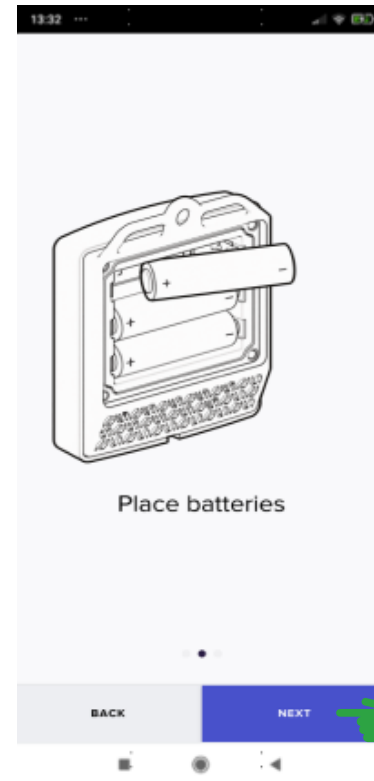
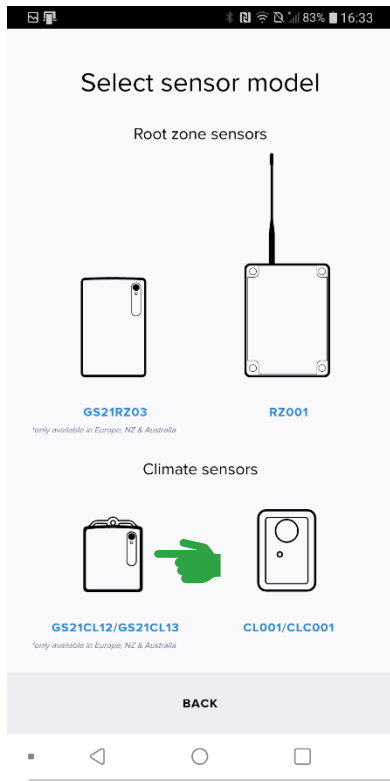

Step 4: Add GroSens Climate sensor

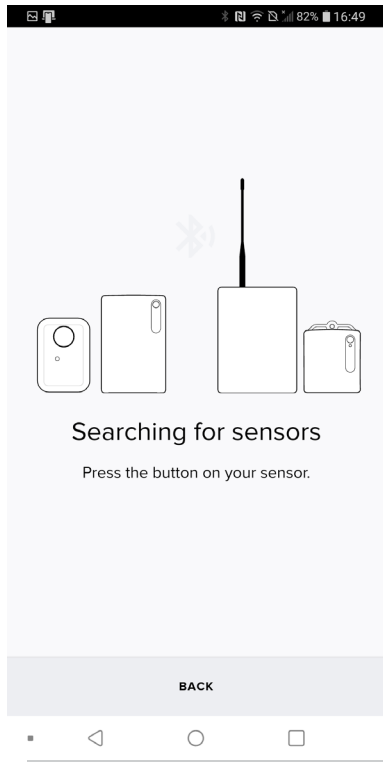

1 Press the button on the GroSens climate sensor. The sensor number will appear in app

2 Light will start flashing

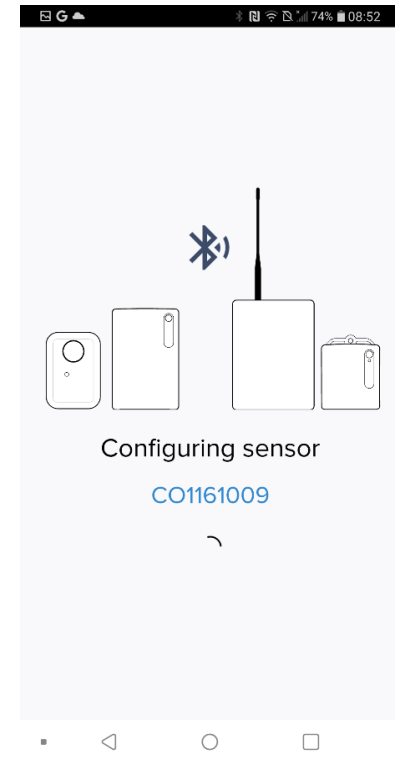
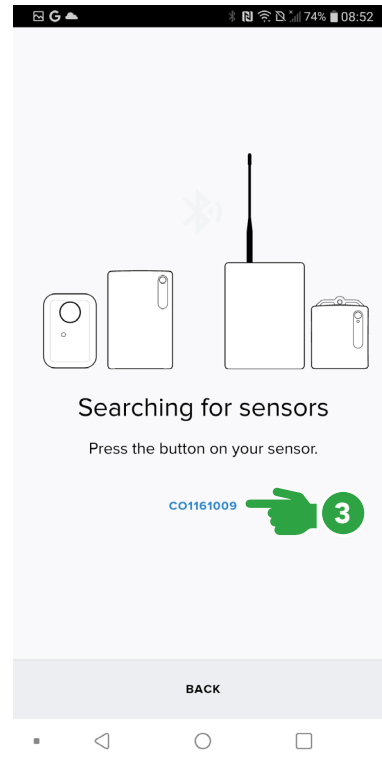

3 GroSens climate sensor number will appear on the screen. Click on it.

Step 5: Create a room/section

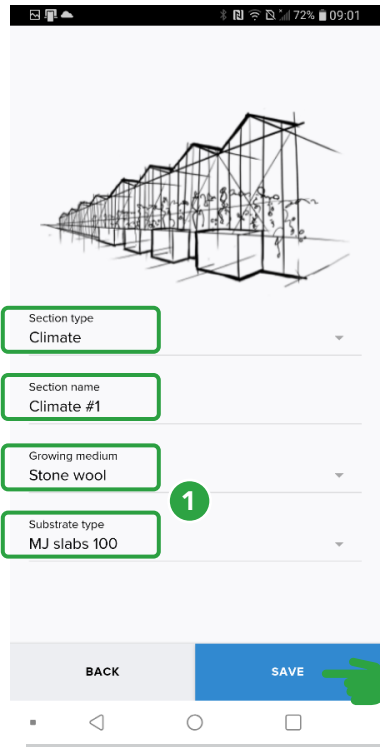
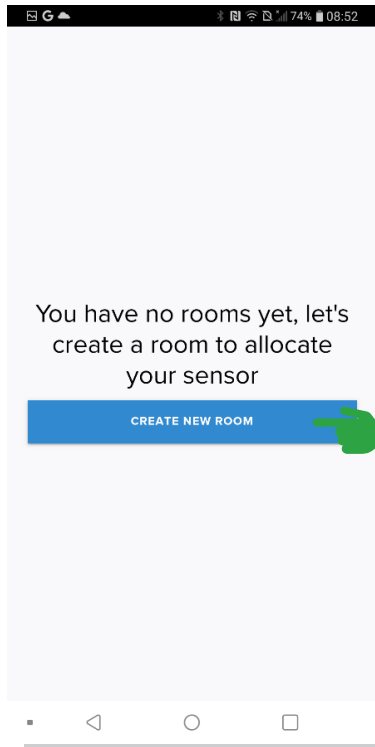

1 Choose a name for your room and select correct substrate type

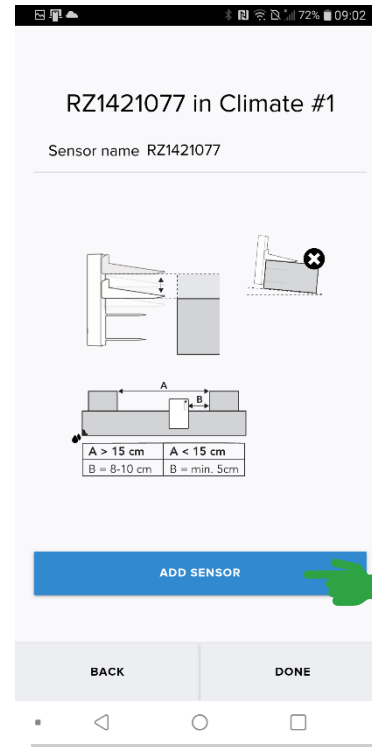
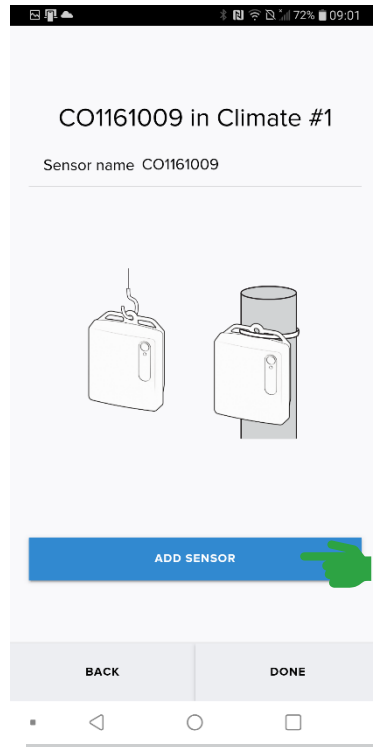

NOTE: After setup, it can take up to 5 minutes to see sensor data on the app

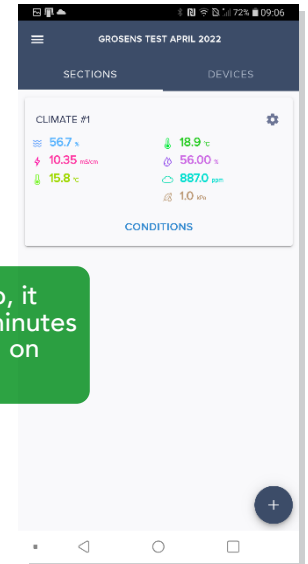
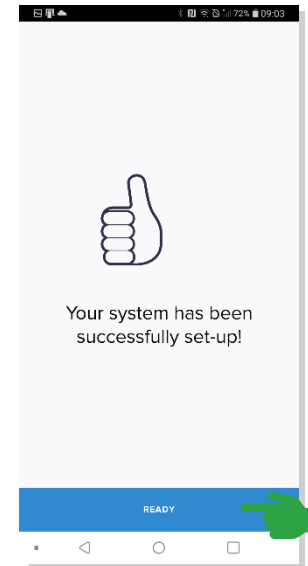

Step 6: View data on Desktop Viewer

When setup of sensors is completed, data can be viewed via your web browser (desktop viewer).

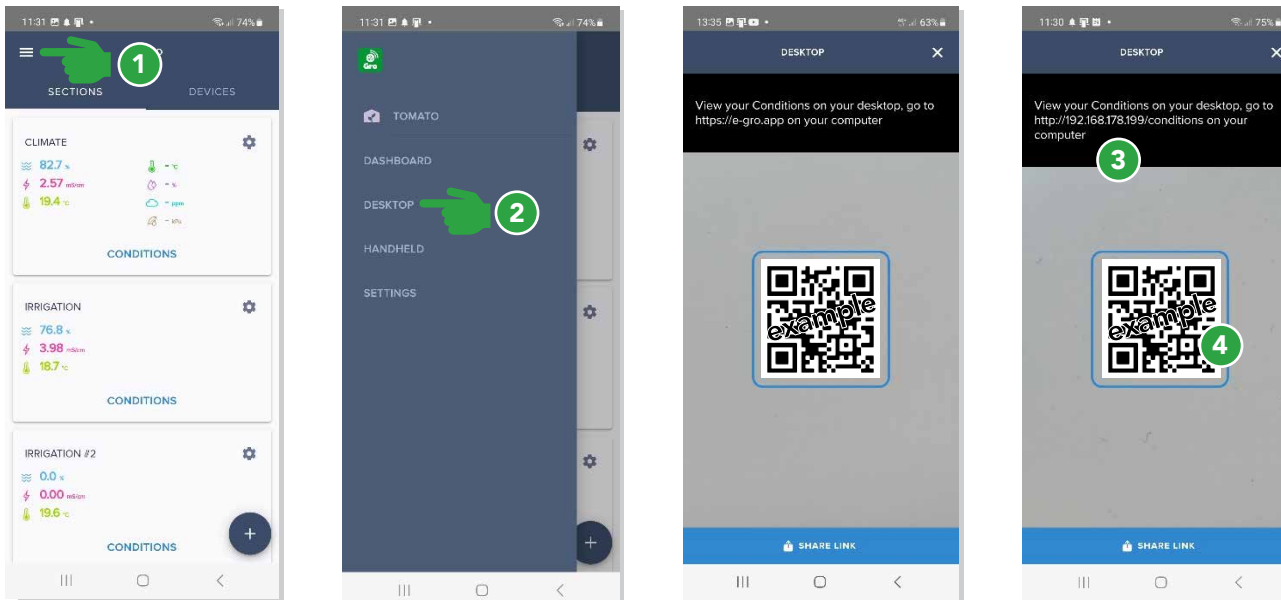

- 1 Press the hamburger menu [three lines]
- 2 Press DESKTOP
- 3 Depending whether your phone is connected to the local network (of the bridge) or the internet, the app will advise you to connect to the IP address via your browser or to https://e-gro.app
- 4 Scan QR code on the web page (see next slide)

Step 6: View data on Desktop Viewer

Open GroSens Bridge web page in your internet browser (google chrome is recommended)

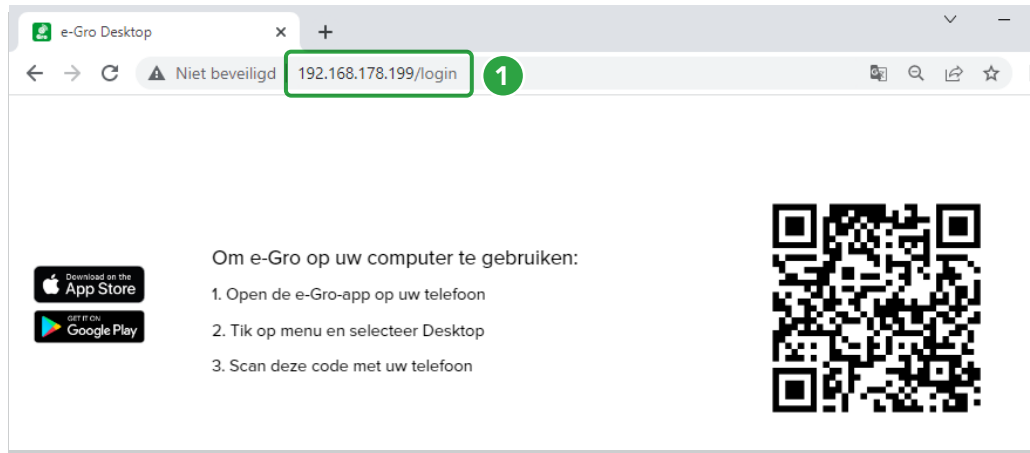

① Via IP address. Most reliable if you are on the same network as the bridge (wifi and wired). If IP address of the bridge changes, you need to change this address also!

② Via <https://e-gro.app>. Recommended if you are not on the same network as the bridge. Needs on a working internet connection of both your PC and the bridge

③ Via [bridgename.local](#) (bridge name can be found on the back of the bridge: E or BR + 6 digits). Recommended if you have a wired ethernet connection to the bridge

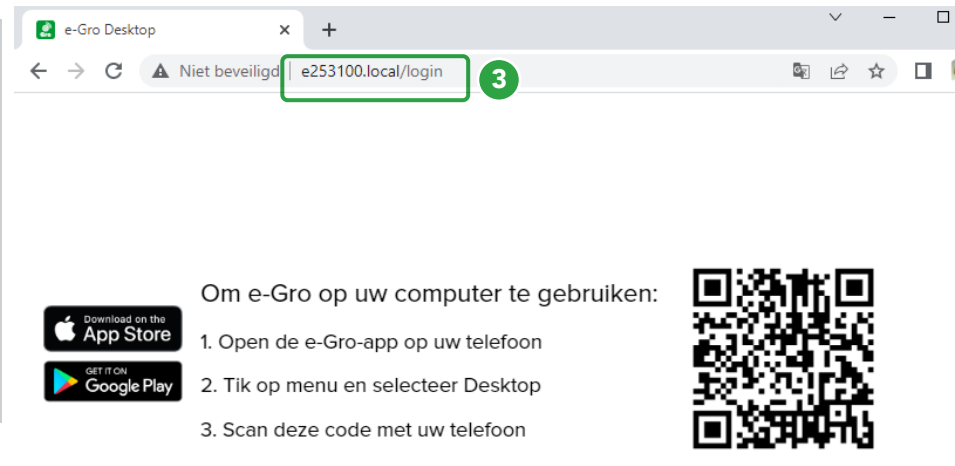
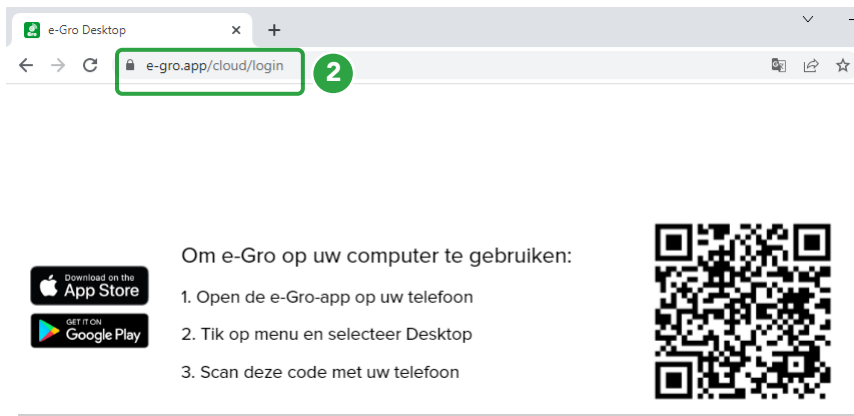

Compatibility with GroSens 1.0 and 2.0 or 2.2 models

On hardware level, GroSens 1.0 and GroSens 2.0 or GroSens 2.2 systems are not compatible due to differences in communication technology and software:

- You **cannot** connect a GroSens 1.0 sensor to a GroSens 2.0 or GroSens 2.2 system and vice versa
- Different gateways and convertors are required

Solution path here is to send data from GroSens 1.0 Smartbox to a GroSens 2.0 or GroSens 2.2 bridge.

- Grower can see old and new sensors in the GroSens 2.0 or GroSens 2.2 system
- Trouble shooting on hardware for the GroSens 1.0 system is still done via Smartbox

Technical:

- Smartbox and bridge should be in the same network (same IP range, typical 192.168.x.y)
- Connecting smartbox to a bridge can be done via de app!

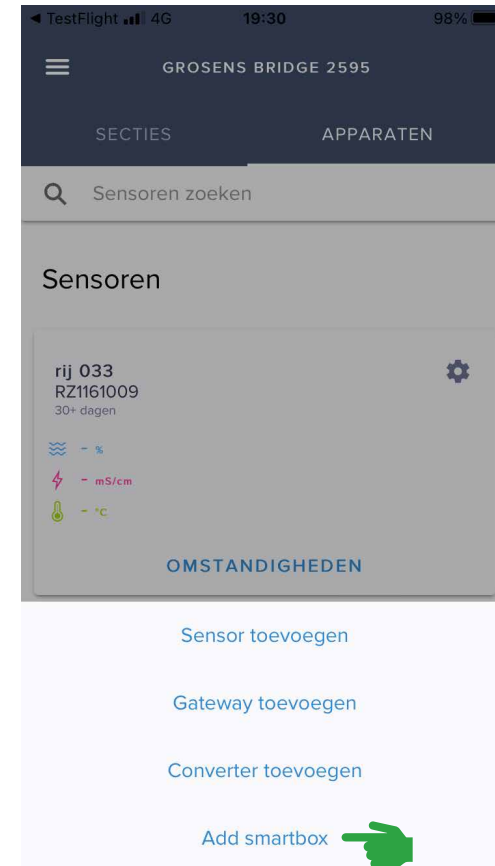

Optional step: connecting existing GroSens Smartbox to the Bridge.

1 Click + sign in devices tab and select add smartbox

2 Fill in the IP address listed on the Smartbox LCD screen and press connect smartbox

Optional step: connecting existing GroSens Smartbox to the Bridge.

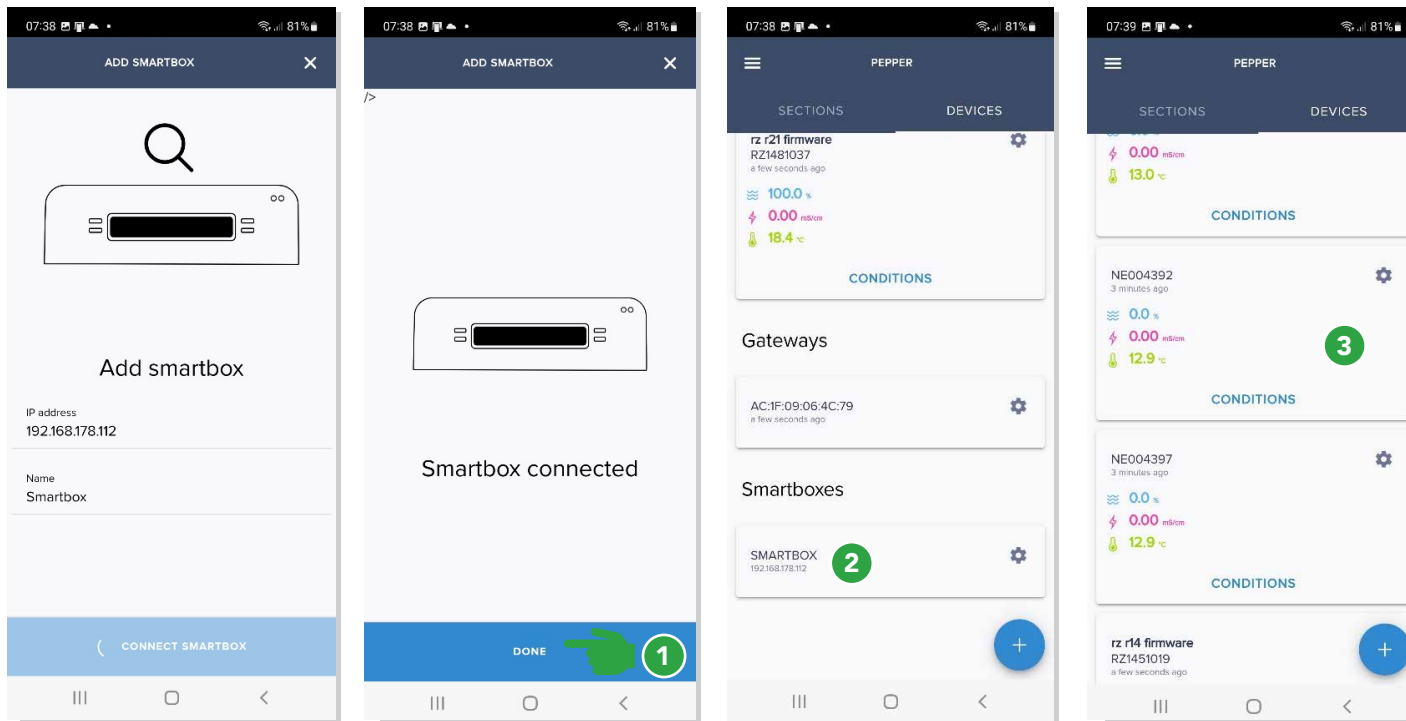

1 Smartbox will be connected to the bridge. Press done.

2 Smartbox will be visible in devices overview

3 Smartbox 1.0 sensors will become visible in devices overview within 10 minutes.

Optional step: Connecting a Converter

In order to use the Rootzone values of the GroSens system on a climate computer, a converter can be purchased. This converter converts the EC, WC and Temperature values of a room/section to voltages, which can be sent to a climate computer.

CAUTION: Do NOT press the reset button on the converter

For every room/section you want values to be sent to the climate computer, you will need one converter (1 converter per room/section). Every converter needs a power supply and ethernet connection on the network.



1

VO0 (0-5 volts): WC 0-100%
VO1 (0-5 volts): EC 0-20 mS/cm
VO2 (0-5 volts): Temperature 0-50 degrees Celsius

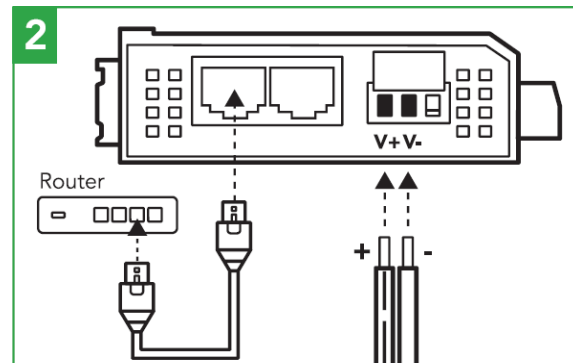

VO0+ VO0- VO1+ VO1- VO2+ VO2-

Warning: Do not remove tape or use reset button
(this will reset to fixed IP iso DHCP, no connection to bridge possible anymore) Converter needs to be replaced!



3 Download the e-Gro Companion app to continue



Optional step: Connecting a Converter

Connecting the power supply



- 1 Connect terminal block to the converter
- 2 Screw the power supply cables to the terminal block. The cable with the grey stripes is the V+, the full black one the V-, t
- 3 Plug in the power supply, check if power orange light lights up.

Optional step: Connecting to a Converter

Connecting to ethernet

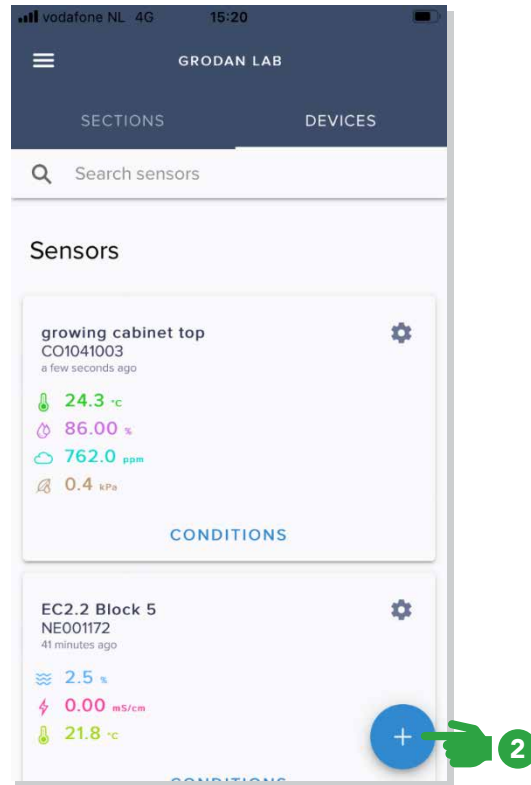

1 Connect the converter via ethernet cable on the same network as the bridge.

2 Open the e-Gro app on your phone. Click + sign in the devices tab

Optional step: Connecting to a Converter

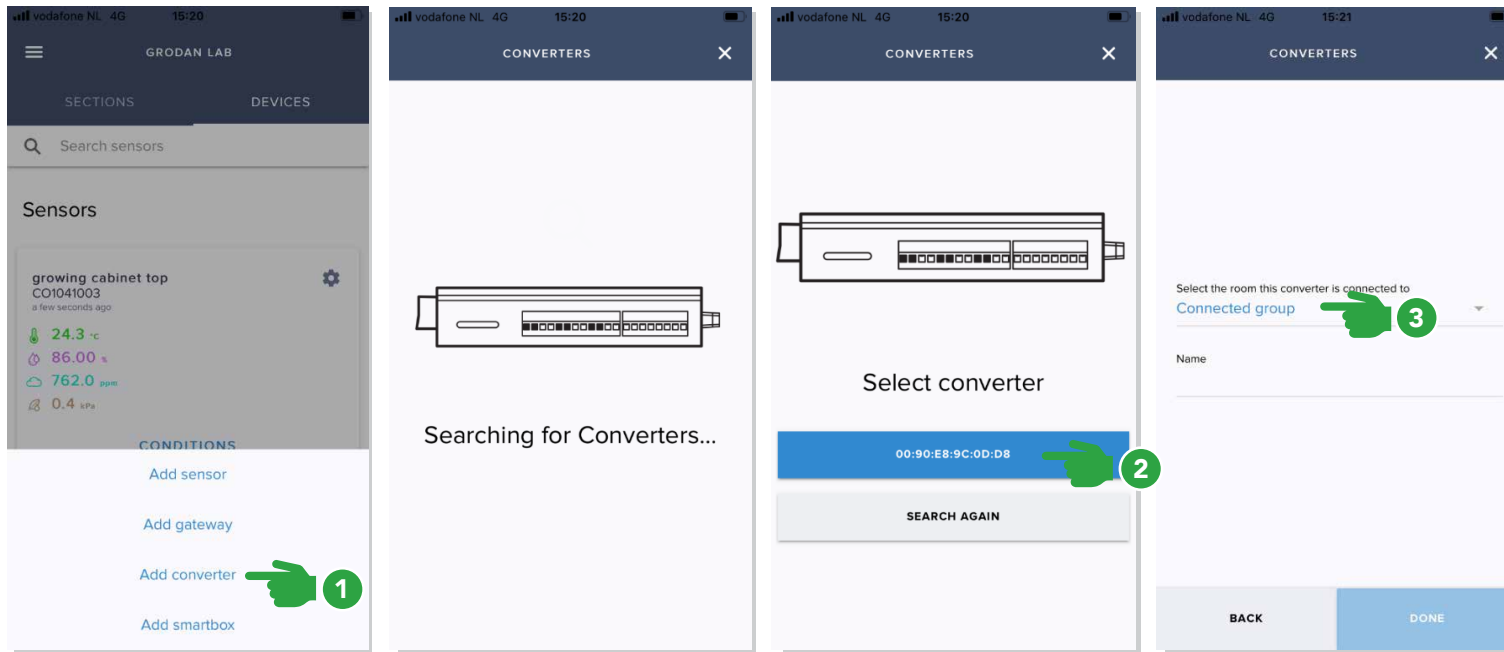

1 Select Add converter

2 Select the converter by matching the MAC address found on the back of the converter (in case multiple converters are found)

3 Select the room from which the converter should convert the EC/WC/temperature values to voltages

Connecting converter

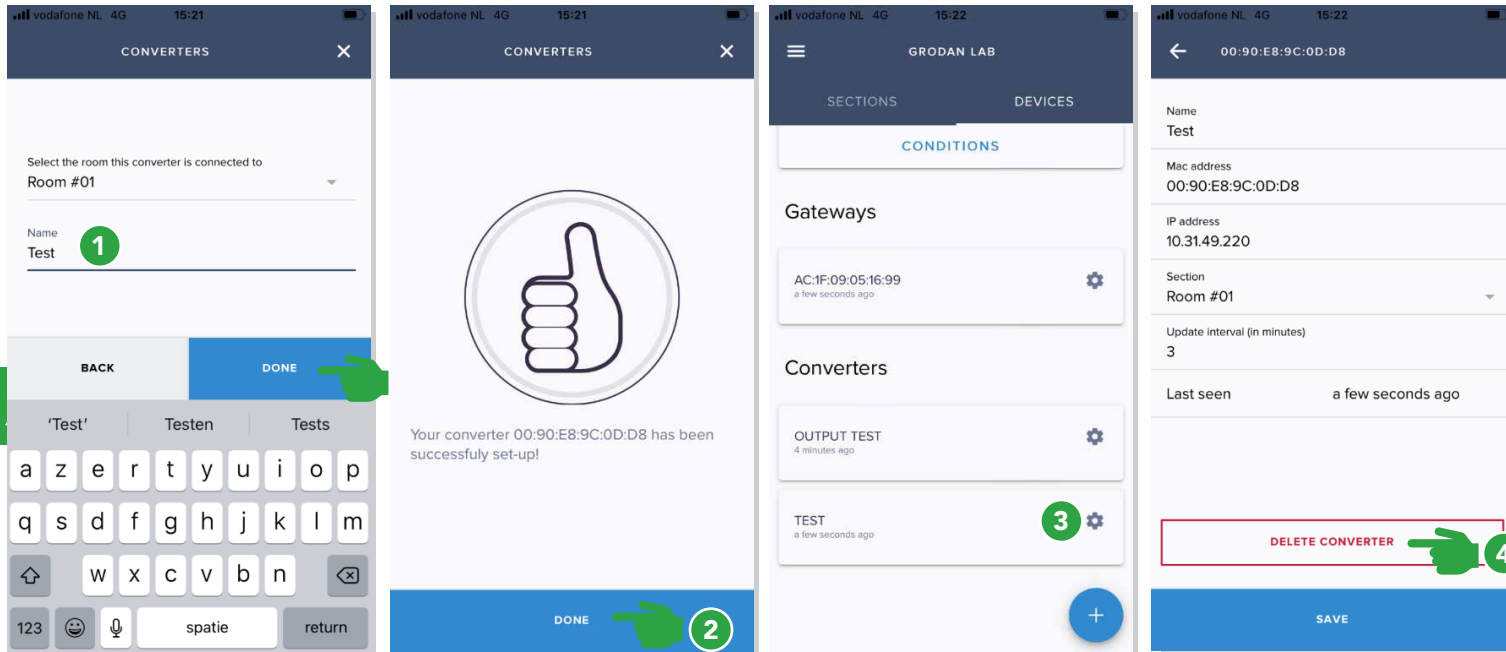

① Name the Converter and press Done

② Converter is operational, via the VO0, VO1 and VO2 ports that you can connect the converter to the climate computer.

③ In the devices tab, you can view and edit converter settings.

④ There is also a possibility to delete the converter

The Grodan Group supplies innovative, sustainable stone wool substrate solutions for the professional horticultural sector. Based on Precision Growing principles, these solutions are particularly applied to the cultivation of vegetables and flowers. In addition to its stone wool substrates, the Grodan Group also provides tailor-made advice and tools to support Precision Growing and thus facilitate the sustainable production of healthy, safe and tasty fresh produce for consumers.

Grodan, a division of ROCKWOOL

Industrieweg 15
Postbus 1160, 6040 KD Roermond
The Netherlands
T +31 (0)475 35 30 20
F +31 (0)475 35 37 16
info@grodan.com
www.grodan.com



ROCKWOOL® and Grodan® are registered trademarks of the ROCKWOOL Group.